

Varenummer: 03446110
Beskrivelse: Fluro Heavy Duty Ledleje GE 110 GW-2RS
Hul Ø110
Note: 110

Mål

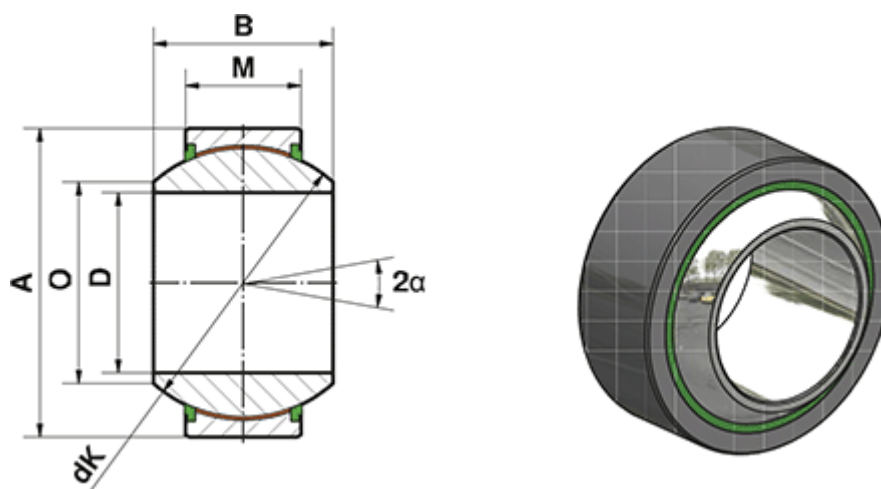

= -	Dynamisk belastning C (kN) = 2685
= -	M = 70
= -	O = 124.8
A = 180	Statisk belastning C0 (kN) = 4475
a (grader) = 12	Vægt (g) = 9800
B = 100	
D = 110	
dK = 160	